

SPECIFICATIONS

**VITA BELLA
PULLS**

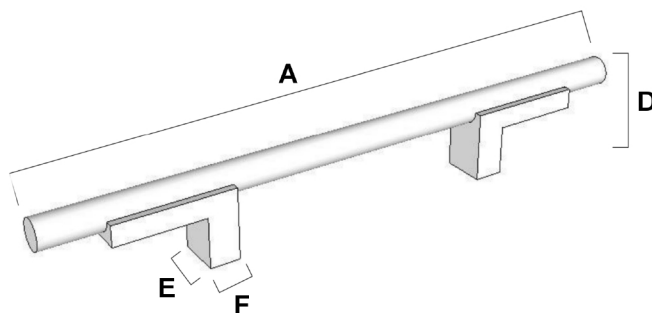

FEATURES

- Transitional styling
- Multiple finishes
- Concealed installation

WARRANTY

Limited lifetime

FINISHES

- Matte Black (MB)
- Champagne (CHP)
- Matte Nickel (MN)
- Champagne/Matte Black (CHP/MB)
- Matte Nickel/Matte Black (MN/MB)

MATERIAL

Aluminum

Item#	A	B	C	D	E (L)	F (W)
A2803-12	16 21/64"	12"	5/16"	1 1/4"	5/16"	9/16"

KEY:

- A - Overall Length
- B - Center to Center
- C - Width
- D - Projection
- E - Mount Length
- F - Mount Width

NOTE: Dimensions and specifications are subject to change without notice.