

**SPECIFICATIONS**

**VITA BELLA  
PULLS**

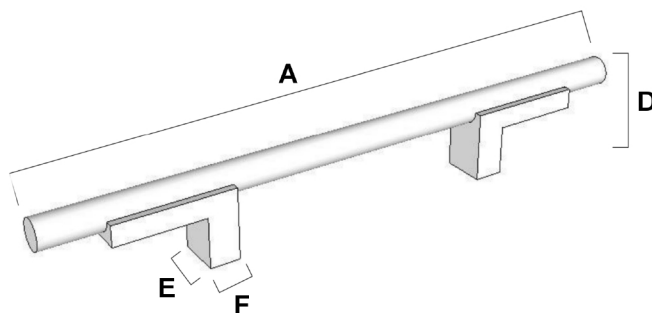

**FEATURES**

- Transitional styling
- Multiple finishes
- Concealed installation

**WARRANTY**

Limited lifetime

**FINISHES**

- Matte Black (MB)
- Champagne (CHP)
- Matte Nickel (MN)
- Champagne/Matte Black (CHP/MB)
- Matte Nickel/Matte Black (MN/MB)

**MATERIAL**

Aluminum

Item#	A	B	C	D	E (L)	F (W)
A2803-4	8 21/64"	4"	5/16"	1 1/4"	5/16"	9/16"

**KEY:**

- A - Overall Length
- B - Center to Center
- C - Width
- D - Projection
- E - Mount Length
- F - Mount Width

NOTE: Dimensions and specifications are subject to change without notice.